



# NORZAGARAY WATER DISTRICT

1639 P. DELA MERCED ST., POBLACION, NORZAGARAY, BULACAN  
VILLARAMA HIGHWAY, POBLACION, NORZAGARAY, BULACAN



Management  
System  
ISO 9001:2015



www.tuv.com  
ID 9108633852

## PHILIPPINE BIDDING DOCUMENTS

# Procurement GI, DI and Brass Fittings

# Table of Contents

<b>Glossary of Acronyms, Terms, and Abbreviations</b>	2
<b>Section II. Instructions to Bidders</b>	7
1. Scope of Bid	7
2. Funding Information	7
3. Bidding Requirements	7
4. Corrupt, Fraudulent, Collusive, and Coercive Practices	7
5. Eligible Bidders	8
6. Origin of Goods	9
7. Subcontracts	9
8. Pre-Bid Conference	10
9. Clarification and Amendment of Bidding Documents	10
10. Documents comprising the Bid: Eligibility and Technical Components	10
11. Documents comprising the Bid: Financial Component	10
12. Bid Prices	11
13. Bid and Payment Currencies	12
14. Bid Security	12
15. Sealing and Marking of Bids	12
16. Deadline for Submission of Bids	13
17. Opening and Preliminary Examination of Bids	13
18. Domestic Preference	13
19. Detailed Evaluation and Comparison of Bids	13
20. Post-Qualification	14
21. Signing of the Contract	15
<b>Section III. Bid Data Sheet</b>	18
<b>Section IV. General Conditions of Contract</b>	18
1. Scope of Contract	18
2. Advance Payment and Terms of Payment	18
3. Performance Security	18
4. Inspection and Tests	19
5. Warranty	19
6. Liability of the Supplier	19
<b>Section V. Special Conditions of Contract</b>	20
<b>Section VI. Schedule of Requirements</b>	24
<b>Section VII. Technical Specifications</b>	26
<b>Section VIII. Checklist of Technical and Financial Documents</b>	31

# *Glossary of Acronyms, Terms, and Abbreviations*

**ABC** – Approved Budget for the Contract.

**BAC** – Bids and Awards Committee.

**Bid** – A signed offer or proposal to undertake a contract submitted by a bidder in response to and in consonance with the requirements of the bidding documents. Also referred to as *Proposal* and *Tender*. (2016 revised IRR, Section 5[c])

**Bidder** – Refers to a contractor, manufacturer, supplier, distributor and/or consultant who submits a bid in response to the requirements of the Bidding Documents. (2016 revised IRR, Section 5[d])

**Bidding Documents** – The documents issued by the Procuring Entity as the bases for bids, furnishing all information necessary for a prospective bidder to prepare a bid for the Goods, Infrastructure Projects, and/or Consulting Services required by the Procuring Entity. (2016 revised IRR, Section 5[e])

**BIR** – Bureau of Internal Revenue.

**BSP** – Bangko Sentral ng Pilipinas.

**Consulting Services** – Refer to services for Infrastructure Projects and other types of projects or activities of the GOP requiring adequate external technical and professional expertise that are beyond the capability and/or capacity of the GOP to undertake such as, but not limited to: (i) advisory and review services; (ii) pre-investment or feasibility studies; (iii) design; (iv) construction supervision; (v) management and related services; and (vi) other technical services or special studies. (2016 revised IRR, Section 5[i])

**CDA** - Cooperative Development Authority.

**Contract** – Refers to the agreement entered into between the Procuring Entity and the Supplier or Manufacturer or Distributor or Service Provider for procurement of Goods and Services; Contractor for Procurement of Infrastructure Projects; or Consultant or Consulting Firm for Procurement of Consulting Services; as the case may be, as recorded in the Contract Form signed by the parties, including all attachments and appendices thereto and all documents incorporated by reference therein.

**CIF** – Cost Insurance and Freight.

**CIP** – Carriage and Insurance Paid.

**CPI** – Consumer Price Index.

**DDP** – Refers to the quoted price of the Goods, which means “delivered duty paid.”

**DTI** – Department of Trade and Industry.

**EXW** – Ex works.

**FCA** – “Free Carrier” shipping point.

**FOB** – “Free on Board” shipping point.

**Foreign-funded Procurement or Foreign-Assisted Project**– Refers to procurement whose funding source is from a foreign government, foreign or international financing institution as specified in the Treaty or International or Executive Agreement. (2016 revised IRR, Section 5[b]).

**Framework Agreement** – Refers to a written agreement between a procuring entity and a supplier or service provider that identifies the terms and conditions, under which specific purchases, otherwise known as “Call-Offs,” are made for the duration of the agreement. It is in the nature of an option contract between the procuring entity and the bidder(s) granting the procuring entity the option to either place an order for any of the goods or services identified in the Framework Agreement List or not buy at all, within a minimum period of one (1) year to a maximum period of three (3) years. (GPPB Resolution No. 27-2019)

**GFI** – Government Financial Institution.

**GOCC** – Government-owned and/or –controlled corporation.

**Goods** – Refer to all items, supplies, materials and general support services, except Consulting Services and Infrastructure Projects, which may be needed in the transaction of public businesses or in the pursuit of any government undertaking, project or activity, whether in the nature of equipment, furniture, stationery, materials for construction, or personal property of any kind, including non-personal or contractual services such as the repair and maintenance of equipment and furniture, as well as trucking, hauling, janitorial, security, and related or analogous services, as well as procurement of materials and supplies provided by the Procuring Entity for such services. The term “related” or “analogous services” shall include, but is not limited to, lease or purchase of office space, media advertisements, health maintenance services, and other services essential to the operation of the Procuring Entity. (2016 revised IRR, Section 5[r])

**GOP** – Government of the Philippines.

**GPPB** – Government Procurement Policy Board.

**INCOTERMS** – International Commercial Terms.

**Infrastructure Projects** – Include the construction, improvement, rehabilitation, demolition, repair, restoration or maintenance of roads and bridges, railways, airports, seaports, communication facilities, civil works components of information technology projects, irrigation, flood control and drainage, water supply, sanitation, sewerage and solid waste management systems, shore protection, energy/power and electrification facilities, national

buildings, school buildings, hospital buildings, and other related construction projects of the government. Also referred to as *civil works or works*. (2016 revised IRR, Section 5[u])

**LGUs** – Local Government Units.

**NFCC** – Net Financial Contracting Capacity.

**NGA** – National Government Agency.

**PhilGEPS** - Philippine Government Electronic Procurement System.

**Procurement Project** – refers to a specific or identified procurement covering goods, infrastructure project or consulting services. A Procurement Project shall be described, detailed, and scheduled in the Project Procurement Management Plan prepared by the agency which shall be consolidated in the procuring entity's Annual Procurement Plan. (GPPB Circular No. 06-2019 dated 17 July 2019)

**PSA** – Philippine Statistics Authority.

**SEC** – Securities and Exchange Commission.

**SLCC** – Single Largest Completed Contract.

**Supplier** – refers to a citizen, or any corporate body or commercial company duly organized and registered under the laws where it is established, habitually established in business and engaged in the manufacture or sale of the merchandise or performance of the general services covered by his bid. (Item 3.8 of GPPB Resolution No. 13-2019, dated 23 May 2019). Supplier as used in these Bidding Documents may likewise refer to a distributor, manufacturer, contractor, or consultant.

**UN** – United Nations.

## INVITATION TO BID FOR PROCUREMENT OF GI, DI AND BRASS FITTINGS

1. The **Norzagaray Water District (NorWD)**, through the Corporate Operating Budget for the contract approved by the governing Boards intends to apply the sum of **Two Million Four Hundred Fifty Eight Thousand Seven Hundred Eighty Five Pesos and Thirty Eight (Php. 2,458,785.38 )** being the ABC to payments under the contract for **Procurement of GI, DI and Brass Fittings**. Bids received in excess of the ABC shall be automatically rejected at bid opening.
2. The **NorWD** now invites bids for the above Procurement Project. Delivery of the Goods is required by **thirty (30) days after the receipt of Notice to Proceed**. Bidders should have completed, within three (3) years from the date of submission and receipt of bids, a contract similar to the Project. The description of an eligible bidder is contained in the Bidding Documents, particularly, in Section II (Instructions to Bidders).
3. Bidding will be conducted through open competitive bidding procedures using a non-discretionary “*pass/fail*” criterion as specified in the 2016 revised Implementing Rules and Regulations (IRR) of Republic Act (RA) No. 9184.
4. Prospective Bidders may obtain further information from **NorWD** and inspect the Bidding Documents at the address given below during Monday to Friday at 8:00am - 5:00pm starting **November 28, 2023**.
5. A complete set of Bidding Documents may be acquired by interested Bidders on **November 28 – December 19, 2023** from the given address below and upon payment of a non-refundable fee for the Bidding Documents of Five Thousand pesos(**Php 5,000.00**)
6. The **NorWD** will hold a Pre-Bid Conference on **December 5, 2023 10:00am** at **NorWD Board Room, Villarama Highway Poblacion, Norzagaray, Bulacan,** which shall be open to all prospective bidders.
7. Bids must be duly received by the BAC Secretariat at the address below on or before **December 19, 2023 10:00 am**. Late bids shall not be accepted.

8. All Bids must be accompanied by a bid security in any of the acceptable forms and in the amount stated in **ITB** Clause 14.
9. Bid opening shall be on **December 19, 2023 10:00 am** at **NorWD Board Room, Villarama Highway, Poblacion, Norzagaray, Bulacan**. Bids will be opened in the presence of the bidders' representatives who choose to attend the activity.
10. The **NorWD** reserves the right to reject any and all bids, declare a failure of bidding, or not award the contract at any time prior to contract award in accordance with Sections 35.6 and 41 of the 2016 revised IRR of RA No. 9184, without thereby incurring any liability to the affected bidder or bidders.
11. For further information, please refer to:

**Lazaro B. Pascual**  
**NORZAGARAY WATER DISTRICT**  
1639 P. Dela Merced Street, Norzagaray, Bulacan

Cellphone nos : 0915-313-0403; 0917-559-9260  
Phone # : (044) 815-3964  
Fax no : (044) 815-3964  
Email address : norzagaray\_wd@yahoo.com

12. You may visit the following websites:

For downloading of Bidding Documents:

*<https://www.norwd.gov.ph/>*

**LAZARO B. PASCUAL**  
BAC CHAIRMAN

## ***Section II. Instructions to Bidders***

### **1. Scope of Bid**

The Procuring Entity, Norzagaray Water District wishes to receive Bids for the **Procurement of GI, DI, and Brass Fittings**, with identification number **PBGOODS 3-2023**

*[Note: The Project Identification Number is assigned by the Procuring Entity based on its own coding scheme and is not the same as the PhilGEPS reference number, which is generated after the posting of the bid opportunity on the PhilGEPS website.]*

The Procurement Project (referred to herein as “Project”) is composed of one lot with multiple items, the details of which are described in Section VII (Technical Specifications).

### **2. Funding Information**

2.1. The GOP through the source of funding as indicated below for CY 2024 in the amount of **Two Million Four Hundred Fifty Eight Thousand Seven Hundred Eighty Five Pesos and Thirty Eight (Php. 2,458,785.38 )**

2.2. The source of funding is: Corporate Operating Budget

### **3. Bidding Requirements**

The Bidding for the Project shall be governed by all the provisions of RA No. 9184 and its 2016 revised IRR, including its Generic Procurement Manuals and associated policies, rules and regulations as the primary source thereof, while the herein clauses shall serve as the secondary source thereof.

Any amendments made to the IRR and other GPPB issuances shall be applicable only to the ongoing posting, advertisement, or **IB** by the BAC through the issuance of a supplemental or bid bulletin.

The Bidder, by the act of submitting its Bid, shall be deemed to have verified and accepted the general requirements of this Project, including other factors that may affect the cost, duration and execution or implementation of the contract, project, or work and examine all instructions, forms, terms, and project requirements in the Bidding Documents.

### **4. Corrupt, Fraudulent, Collusive, and Coercive Practices**

The Procuring Entity, as well as the Bidders and Suppliers, shall observe the highest standard of ethics during the procurement and execution of the contract. They or through an agent shall not engage in corrupt, fraudulent, collusive, coercive, and



obstructive practices defined under Annex “I” of the 2016 revised IRR of RA No. 9184 or other integrity violations in competing for the Project.

## 5. Eligible Bidders

5.1. Only Bids of Bidders found to be legally, technically, and financially capable will be evaluated.

5.2.

a. Foreign ownership exceeding those allowed under the rules may participate pursuant to:

i. When a Treaty or International or Executive Agreement as provided in Section 4 of the RA No. 9184 and its 2016 revised IRR allow foreign bidders to participate;

ii. Citizens, corporations, or associations of a country, included in the list issued by the GPPB, the laws or regulations of which grant reciprocal rights or privileges to citizens, corporations, or associations of the Philippines;

iii. When the Goods sought to be procured are not available from local suppliers; or

iv. When there is a need to prevent situations that defeat competition or restrain trade.

b. Foreign ownership limited to those allowed under the rules may participate in this Project.

5.3. Pursuant to Section 23.4.1.3 of the 2016 revised IRR of RA No.9184, the Bidder shall have an SLCC that is at least one (1) contract similar to the Project the value of which, adjusted to current prices using the PSA’s CPI, must be at least equivalent to:

a. For the procurement of Non-expendable Supplies and Services: The Bidder must have completed a single contract that is similar to this Project, equivalent to at least fifty percent (50%) of the ABC.

b. For the procurement of Expendable Supplies: The Bidder must have completed a single contract that is similar to this Project, equivalent to at least twenty-five percent (25%) of the ABC.

c. For procurement where the Procuring Entity has determined, after the conduct of market research, that imposition of either (a) or (b) will likely result to failure of bidding or monopoly that will defeat the purpose of public bidding: the Bidder should comply with the following requirements: *[Select either failure or monopoly of bidding based on market research conducted]*

- i. Completed at least two (2) similar contracts, the aggregate amount of which should be equivalent to at least *fifty percent (50%) in the case of non-expendable supplies and services or twenty-five percent (25%) in the case of expendable supplies*] of the ABC for this Project; and
  - ii. The largest of these similar contracts must be equivalent to at least half of the percentage of the ABC as required above.
- 5.4. The Bidders shall comply with the eligibility criteria under Section 23.4.1 of the 2016 IRR of RA No. 9184.

## 6. Origin of Goods

There is no restriction on the origin of goods other than those prohibited by a decision of the UN Security Council taken under Chapter VII of the Charter of the UN, subject to Domestic Preference requirements under **ITB** Clause 18.

## 7. Subcontracts

- 7.1. The Bidder may subcontract portions of the Project to the extent allowed by the Procuring Entity as stated herein, but in no case more than twenty percent (20%) of the Project.

The Procuring Entity has prescribed that:

*[Select one, delete other/s]*

- Subcontracting is not allowed.

  - 7.2. *[If Procuring Entity has determined that subcontracting is allowed during the bidding, state:]* The Bidder must submit together with its Bid the documentary requirements of the subcontractor(s) complying with the eligibility criteria stated in **ITB** Clause 5 in accordance with Section 23.4 of the 2016 revised IRR of RA No. 9184 pursuant to Section 23.1 thereof.
  - 7.3. *[If subcontracting is allowed during the contract implementation stage, state:]* The Supplier may identify its subcontractor during the contract implementation stage. Subcontractors identified during the bidding may be changed during the implementation of this Contract. Subcontractors must submit the documentary requirements under Section 23.1 of the 2016 revised IRR of RA No. 9184 and comply with the eligibility criteria specified in **ITB** Clause 5 to the implementing or end-user unit.
  - 7.4. Subcontracting of any portion of the Project does not relieve the Supplier of any liability or obligation under the Contract. The Supplier will be responsible for the acts, defaults, and negligence of any subcontractor, its agents, servants, or

workmen as fully as if these were the Supplier's own acts, defaults, or negligence, or those of its agents, servants, or workmen.

## **8. Pre-Bid Conference**

The Procuring Entity will hold a pre-bid conference for this Project on the specified date and time and either at its physical address *{[insert if applicable]}* and/or through videoconferencing/webcasting} as indicated in paragraph 6 of the **IB**.

## **9. Clarification and Amendment of Bidding Documents**

Prospective bidders may request for clarification on and/or interpretation of any part of the Bidding Documents. Such requests must be in writing and received by the Procuring Entity, either at its given address or through electronic mail indicated in the **IB**, at least ten (10) calendar days before the deadline set for the submission and receipt of Bids.

## **10. Documents comprising the Bid: Eligibility and Technical Components**

- 10.1. The first envelope shall contain the eligibility and technical documents of the Bid as specified in **Section VIII (Checklist of Technical and Financial Documents)**.
- 10.2. The Bidder's SLCC as indicated in **ITB** Clause 5.3 should have been completed within *[state relevant period as provided in paragraph 2 of the IB]* prior to the deadline for the submission and receipt of bids.
- 10.3. If the eligibility requirements or statements, the bids, and all other documents for submission to the BAC are in foreign language other than English, it must be accompanied by a translation in English, which shall be authenticated by the appropriate Philippine foreign service establishment, post, or the equivalent office having jurisdiction over the foreign bidder's affairs in the Philippines. Similar to the required authentication above, for Contracting Parties to the Apostille Convention, only the translated documents shall be authenticated through an apostille pursuant to GPPB Resolution No. 13-2019 dated 23 May 2019. The English translation shall govern, for purposes of interpretation of the bid.

## **11. Documents comprising the Bid: Financial Component**

- 11.1. The second bid envelope shall contain the financial documents for the Bid as specified in **Section VIII (Checklist of Technical and Financial Documents)**.
- 11.2. If the Bidder claims preference as a Domestic Bidder or Domestic Entity, a certification issued by DTI shall be provided by the Bidder in accordance with Section 43.1.3 of the 2016 revised IRR of RA No. 9184.
- 11.3. Any bid exceeding the ABC indicated in paragraph 1 of the **IB** shall not be accepted.

- 11.4. For Foreign-funded Procurement, a ceiling may be applied to bid prices provided the conditions are met under Section 31.2 of the 2016 revised IRR of RA No. 9184.
- 11.5. *[Include if Framework Agreement will be used:]* Financial proposals for single or multi-year Framework Agreement shall be submitted before the deadline of submission of bids as prescribed in the **IB**. For multi-year Framework Agreement, evaluation of the financial proposal during this stage is for purposes of determining eligibility and whether or not such financial proposal is within the ABC.

## 12. Bid Prices

- 12.1. Prices indicated on the Price Schedule shall be entered separately in the following manner:
- a. For Goods offered from within the Procuring Entity's country:
    - i. The price of the Goods quoted EXW (ex-works, ex-factory, ex-warehouse, ex-showroom, or off-the-shelf, as applicable);
    - ii. The cost of all customs duties and sales and other taxes already paid or payable;
    - iii. The cost of transportation, insurance, and other costs incidental to delivery of the Goods to their final destination; and
    - iv. The price of other (incidental) services, if any, listed in the **BDS**.
  - b. For Goods offered from abroad:
    - i. Unless otherwise stated in the **BDS**, the price of the Goods shall be quoted delivered duty paid (DDP) with the place of destination in the Philippines as specified in the **BDS**. In quoting the price, the Bidder shall be free to use transportation through carriers registered in any eligible country. Similarly, the Bidder may obtain insurance services from any eligible source country.
    - ii. The price of other (incidental) services, if any, as listed in the **BDS**.
- 12.2. *[Include if Framework Agreement will be used:]* For Framework Agreement, the following should also apply in addition to Clause 12.1:
- a. For a single year Framework Agreement, the prices quoted by the Bidder shall be fixed during the Bidder's performance of the contract and not subject to variation or escalation on any account. Price schedules required under Clause 12.1 shall be submitted with the bidding documents.
  - b. For a multi-year Framework Agreement, the prices quoted by the Bidder during submission of eligibility documents shall be the ceiling and the price

quoted during mini-competition must not exceed the initial price offer. The price quoted during call for mini-competition shall be fixed during the Bidder's performance of that Call-off and not subject to variation or escalation on any account. Price schedules required under Clause 12.1 shall be submitted with the bidding documents.

### 13. Bid and Payment Currencies

13.1. For Goods that the Bidder will supply from outside the Philippines, the bid prices may be quoted in the local currency or tradeable currency accepted by the BSP at the discretion of the Bidder. However, for purposes of bid evaluation, Bids denominated in foreign currencies, shall be converted to Philippine currency based on the exchange rate as published in the BSP reference rate bulletin on the day of the bid opening.

13.2. Payment of the contract price shall be made in:

*[Select one, delete the other/s]*

a. Philippine Pesos.

b. *[indicate currency if procurement involves a foreign-denominated bid as allowed by the Procuring Entity, which shall be tradeable or acceptable by the BSP].*

### 14. Bid Security

14.1. The Bidder shall submit a Bid Securing Declaration<sup>1</sup> or any form of Bid Security in the amount indicated in the **BDS**, which shall be not less than the percentage of the ABC in accordance with the schedule in the **BDS**.

14.2. The Bid and bid security shall be valid until *[May 17, 2024]*. Any Bid not accompanied by an acceptable bid security shall be rejected by the Procuring Entity as non-responsive.

14.3. *[Include if Framework Agreement will be used:]* In the case of Framework Agreement, other than the grounds for forfeiture under the 2016 revised IRR, the bid security may also be forfeited if the successful bidder fails to sign the Framework Agreement, or fails to furnish the performance security or performance securing declaration. Without prejudice on its forfeiture, bid securities shall be returned only after the posting of performance security or performance securing declaration, as the case may be, by the winning Bidder or compliant Bidders and the signing of the Framework Agreement.

### 15. Sealing and Marking of Bids

Each Bidder shall submit one copy of the first and second components of its Bid.

---

<sup>1</sup> In the case of Framework Agreement, the undertaking shall refer to entering into contract with the Procuring Entity and furnishing of the performance security or the performance securing declaration within ten (10) calendar days from receipt of Notice to Execute Framework Agreement.

The Procuring Entity may request additional hard copies and/or electronic copies of the Bid. However, failure of the Bidders to comply with the said request shall not be a ground for disqualification.

If the Procuring Entity allows the submission of bids through online submission or any other electronic means, the Bidder shall submit an electronic copy of its Bid, which must be digitally signed. An electronic copy that cannot be opened or is corrupted shall be considered non-responsive and, thus, automatically disqualified.

## **16. Deadline for Submission of Bids**

- 16.1. The Bidders shall submit on the specified date and time and either at its physical address or through online submission as indicated in paragraph 7 of the **IB**.
- 16.2. *[Include if Framework Agreement will be used:]* For multi-year Framework Agreement, the submission of bids shall be for the initial evaluation of their technical and financial eligibility. Thereafter, those declared eligible during the said initial eligibility evaluation and entered into a Framework Agreement with the Procuring Entity shall submit anew their best financial offer at the address and on or before the date and time indicated in the Call for each mini-competition.

## **17. Opening and Preliminary Examination of Bids**

- 17.1. The BAC shall open the Bids in public at the time, on the date, and at the place specified in paragraph 9 of the **IB**. The Bidders' representatives who are present shall sign a register evidencing their attendance. In case videoconferencing, webcasting or other similar technologies will be used, attendance of participants shall likewise be recorded by the BAC Secretariat.

In case the Bids cannot be opened as scheduled due to justifiable reasons, the rescheduling requirements under Section 29 of the 2016 revised IRR of RA No. 9184 shall prevail.

- 17.2. The preliminary examination of bids shall be governed by Section 30 of the 2016 revised IRR of RA No. 9184.

## **18. Domestic Preference**

- 18.1. The Procuring Entity will grant a margin of preference for the purpose of comparison of Bids in accordance with Section 43.1.2 of the 2016 revised IRR of RA No. 9184.
- 18.2. *[Include if Framework Agreement will be used:]* For multi-year Framework Agreement, determination of margin of preference shall be conducted every call for Mini-Competition.

## **19. Detailed Evaluation and Comparison of Bids**

- 19.1. The Procuring Entity's BAC shall immediately conduct a detailed evaluation of all Bids rated "passed," using non-discretionary pass/fail criteria. The BAC shall consider the conditions in the evaluation of Bids under Section 32.2 of the 2016 revised IRR of RA No. 9184.

*[Include the following options if Framework Agreement will be used:]*

- a. In the case of single-year Framework Agreement, the Lowest Calculated Bid shall be determined outright after the detailed evaluation;
- b. For multi-year Framework Agreement, the determination of the eligibility and the compliance of bidders with the technical and financial aspects of the projects shall be initially made by the BAC, in accordance with Item 7.4.2 of the Guidelines on the Use of Framework Agreement.
- 19.2. If the Project allows partial bids, bidders may submit a proposal on any of the lots or items, and evaluation will be undertaken on a per lot or item basis, as the case maybe. In this case, the Bid Security as required by **ITB** Clause 14 shall be submitted for each lot or item separately.
- 19.3. The descriptions of the lots or items shall be indicated in **Section VII (Technical Specifications)**, although the ABCs of these lots or items are indicated in the **BDS** for purposes of the NFCC computation pursuant to Section 23.4.2.6 of the 2016 revised IRR of RA No. 9184. The NFCC must be sufficient for the total of the ABCs for all the lots or items participated in by the prospective Bidder.
- 19.4. The Project shall be awarded as follows:

– One Project having several items that shall be awarded as one 1contract.

- 19.5. Except for bidders submitting a committed Line of Credit from a Universal or Commercial Bank in lieu of its NFCC computation, all Bids must include the NFCC computation pursuant to Section 23.4.1.4 of the 2016 revised IRR of RA No. 9184, which must be sufficient for the total of the ABCs for all the lots or items participated in by the prospective Bidder. For bidders submitting the committed Line of Credit, it must be at least equal to ten percent (10%) of the ABCs for all the lots or items participated in by the prospective Bidder.

## **20. Post-Qualification**

- 20.1. *[Include if Framework Agreement will be used:]* For multi-year Framework Agreement, all bidders initially determined to be eligible and financially compliant shall be subject to initial post-qualification. The BAC shall then recommend the execution of a Framework Agreement among all eligible, technically and financially compliant bidders and the Procuring Entity and shall be issued by HoPE a Notice to Execute Framework Agreement. The determination of the Lowest Calculated Bid (LCB) shall not be performed by the BAC until a Mini-Competition is conducted among the bidders who executed a Framework Agreement. When a Call for Mini-Competition is made,

the BAC shall allow the bidders to submit their best financial proposals on such pre-scheduled date, time and place to determine the bidder with the LCB.

- 20.2. Within a non-extendible period of five (5) calendar days from receipt by the Bidder of the notice from the BAC that it submitted the Lowest Calculated Bid, *{[Include if Framework Agreement will be used:]}* or in the case of multi-year Framework Agreement, that it is one of the eligible bidders who have submitted bids that are found to be technically and financially compliant, *}* the Bidder shall submit its latest income and business tax returns filed and paid through the BIR Electronic Filing and Payment System (eFPS) and other appropriate licenses and permits required by law and stated in the **BDS**. *{[Include if Framework Agreement will be used:]}* For every mini-competition in Framework Agreement, the LCB shall likewise submit the required documents for final Post Qualification. *}*

## 21. Signing of the Contract

- 21.1. The documents required in Section 37.2 of the 2016 revised IRR of RA No. 9184 shall form part of the Contract. Additional Contract documents are indicated in the **BDS**.

*[Include the following clauses if Framework Agreement will be used:]*

- 21.2. At the same time as the Procuring Entity notifies the successful Bidder that its bid has been accepted, the Procuring Entity shall send the Framework Agreement Form to the Bidder, which contract has been provided in the Bidding Documents, incorporating therein all agreements between the parties.
- 21.3. Within ten (10) calendar days from receipt of the Notice to Execute Framework Agreement with the Procuring Entity, the successful Bidder or its duly authorized representative shall formally enter into a Framework Agreement with the procuring entity for an amount of One Peso to be paid to the procuring entity as a consideration for the option granted by the procuring entity to procure the items in the Framework Agreement List when the need arises.
- 21.4. The Procuring Entity shall enter into a Framework Agreement with the successful Bidder within the same ten (10) calendar day period provided that all the documentary requirements are complied with.
- 21.5. The following documents shall form part of the Framework Agreement:
- a. Framework Agreement Form;
  - b. Bidding Documents;
  - c. Call-offs;
  - d. Winning bidder's bid, including the Technical and Financial Proposals, and all other documents/statements submitted (*e.g.*, bidder's response to request for clarifications on the bid), including corrections to the bid, if any, resulting from the Procuring Entity's bid evaluation;
  - e. Performance Security or Performance Securing Declaration, as the case may be;



- f. Notice to Execute Framework Agreement; and
- g. Other contract documents that may be required by existing laws and/or specified in the **BDS**.

## Section III. Bid Data Sheet

ITB Clause	
5.3	<p>For this purpose, contracts similar to the Project shall be:</p> <ul style="list-style-type: none"> <li>a. <i>Supply and delivery of GI,DI and Brass Fittings.</i></li> <li>b. Completed within three (3) years prior to the deadline for the submission and receipt of bids.</li> </ul>
7.1	<i>Subcontracting is not allowed</i>
12	The price of the Goods shall be quoted DDP [ <i>state place of destination</i> ] or the applicable International Commercial Terms (INCOTERMS) for this Project.
14.1	<p>The bid security shall be in the form of a Bid Securing Declaration, or any of the following forms and amounts:</p> <ul style="list-style-type: none"> <li>a. The amount of not less than <b>P49,175.71</b> [<i>2% of ABC</i>], if bid security is in cash, cashier's/manager's check, bank draft/guarantee or irrevocable letter of credit; or</li> <li>b. The amount of not less than <b>P122,939.27</b> [<i>5% of ABC</i>] if bid security is in Surety Bond.</li> </ul>
19.3	<i>Not Applicable</i>
20.2	<i>Not Applicable</i>
21.2	<i>Not Applicable</i>

## ***Section IV. General Conditions of Contract***

### **1. Scope of Contract**

This Contract shall include all such items, although not specifically mentioned, that can be reasonably inferred as being required for its completion as if such items were expressly mentioned herein. All the provisions of RA No. 9184 and its 2016 revised IRR, including the Generic Procurement Manual, and associated issuances, constitute the primary source for the terms and conditions of the Contract, and thus, applicable in contract implementation. Herein clauses shall serve as the secondary source for the terms and conditions of the Contract.

This is without prejudice to Sections 74.1 and 74.2 of the 2016 revised IRR of RA No. 9184 allowing the GPPB to amend the IRR, which shall be applied to all procurement activities, the advertisement, posting, or invitation of which were issued after the effectivity of the said amendment.

Additional requirements for the completion of this Contract shall be provided in the **Special Conditions of Contract (SCC)**.

### **2. Advance Payment and Terms of Payment**

- 2.1. Advance payment of the contract amount is provided under Annex “D” of the revised 2016 IRR of RA No. 9184.
- 2.2. The Procuring Entity is allowed to determine the terms of payment on the partial or staggered delivery of the Goods procured, provided such partial payment shall correspond to the value of the goods delivered and accepted in accordance with prevailing accounting and auditing rules and regulations. The terms of payment are indicated in the **SCC**.

*[Include the following clauses if Framework Agreement will be used:]*

- 2.3. For a single-year Framework Agreement, prices charged by the Supplier for Goods delivered and/or services performed under a Call-Off shall not vary from the prices quoted by the Supplier in its bid.
- 2.4. For multi-year Framework Agreement, prices charged by the Supplier for Goods delivered and/or services performed under a Call-Off shall not vary from the prices quoted by the Supplier during conduct of Mini-Competition.

### **3. Performance Security**

Within ten (10) calendar days from receipt of the Notice of Award by the Bidder from the Procuring Entity but in no case later than the signing of the Contract by both parties, the successful Bidder shall furnish the performance security in any of the forms prescribed in Section 39 of the 2016 revised IRR of RA No. 9184. *[Include if Framework Agreement will be used:]* In the case of Framework Agreement, the Bidder

may opt to furnish the performance security or a Performance Securing Declaration as defined under the Guidelines on the Use of Framework Agreement.}

#### **4. Inspection and Tests**

The Procuring Entity or its representative shall have the right to inspect and/or to test the Goods to confirm their conformity to the Project *{[Include if Framework Agreement will be used:]* or Framework Agreement} specifications at no extra cost to the Procuring Entity in accordance with the Generic Procurement Manual. In addition to tests in the **SCC, Section VII (Technical Specifications)** shall specify what inspections and/or tests the Procuring Entity requires, and where they are to be conducted. The Procuring Entity shall notify the Supplier in writing, in a timely manner, of the identity of any representatives retained for these purposes.

All reasonable facilities and assistance for the inspection and testing of Goods, including access to drawings and production data, shall be provided by the Supplier to the authorized inspectors at no charge to the Procuring Entity.

#### **5. Warranty**

5.1 In order to assure that manufacturing defects shall be corrected by the Supplier, a warranty shall be required from the Supplier as provided under Section 62.1 of the 2016 revised IRR of RA No. 9184.

5.2 The Procuring Entity shall promptly notify the Supplier in writing of any claims arising under this warranty. Upon receipt of such notice, the Supplier shall, repair or replace the defective Goods or parts thereof without cost to the Procuring Entity, pursuant to the Generic Procurement Manual.

#### **6. Liability of the Supplier**

The Supplier's liability under this Contract shall be as provided by the laws of the Republic of the Philippines.

If the Supplier is a joint venture, all partners to the joint venture shall be jointly and severally liable to the Procuring Entity.

## *Section V. Special Conditions of Contract*

GCC Clause	
1	<p><i>[List here any additional requirements for the completion of this Contract. The following requirements and the corresponding provisions may be deleted, amended, or retained depending on its applicability to this Contract:]</i></p> <p><b>Delivery and Documents –</b></p> <p>For purposes of the Contract, “EXW,” “FOB,” “FCA,” “CIF,” “CIP,” “DDP” and other trade terms used to describe the obligations of the parties shall have the meanings assigned to them by the current edition of INCOTERMS published by the International Chamber of Commerce, Paris. The Delivery terms of this Contract shall be as follows:</p> <p><i>[For Goods supplied from abroad, state:]</i> “The delivery terms applicable to the Contract are DDP delivered <i>[indicate place of destination]</i>. In accordance with INCOTERMS.”</p> <p><i>[For Goods supplied from within the Philippines, state:]</i> “The delivery terms applicable to this Contract are delivered <i>[indicate place of destination]</i>. Risk and title will pass from the Supplier to the Procuring Entity upon receipt and final acceptance of the Goods at their final destination.”</p> <p>Delivery of the Goods shall be made by the Supplier in accordance with the terms specified in Section VI (Schedule of Requirements).</p> <p>For purposes of this Clause the Procuring Entity’s Representative at the Project Site is <i>[Engr. Silvestre P. de Guzman]</i>.</p> <p><b>Incidental Services –</b></p> <p>The Supplier is required to provide all of the following services, including additional services, if any, specified in Section VI. Schedule of Requirements:</p> <p><i>Select appropriate requirements and delete the rest.</i></p> <ol style="list-style-type: none"> <li>a. performance or supervision of on-site assembly and/or start-up of the supplied Goods;</li> <li>b. furnishing of tools required for assembly and/or maintenance of the supplied Goods;</li> <li>c. furnishing of a detailed operations and maintenance manual for each appropriate unit of the supplied Goods;</li> <li>d. performance or supervision or maintenance and/or repair of the supplied Goods, for a period of time agreed by the parties, provided</li> </ol>

	<p>that this service shall not relieve the Supplier of any warranty obligations under this Contract; and</p>
	<p>e. training of the Procuring Entity’s personnel, at the Supplier’s plant and/or on-site, in assembly, start-up, operation, maintenance, and/or repair of the supplied Goods.</p> <p>f. <i>[Specify additional incidental service requirements, as needed.]</i></p> <p>The Contract price for the Goods shall include the prices charged by the Supplier for incidental services and shall not exceed the prevailing rates charged to other parties by the Supplier for similar services.</p> <p><b>Spare Parts –</b></p> <p>The Supplier is required to provide all of the following materials, notifications, and information pertaining to spare parts manufactured or distributed by the Supplier:</p> <p><i>Select appropriate requirements and delete the rest.</i></p> <ol style="list-style-type: none"> <li>1. such spare parts as the Procuring Entity may elect to purchase from the Supplier, provided that this election shall not relieve the Supplier of any warranty obligations under this Contract; and</li> <li>2. in the event of termination of production of the spare parts: <ol style="list-style-type: none"> <li>i. advance notification to the Procuring Entity of the pending termination, in sufficient time to permit the Procuring Entity to procure needed requirements; and</li> <li>ii. following such termination, furnishing at no cost to the Procuring Entity, the blueprints, drawings, and specifications of the spare parts, if requested.</li> </ol> </li> </ol> <p>The spare parts and other components required are listed in <b>Section VI (Schedule of Requirements)</b> and the costs thereof are included in the contract price.</p> <p>The Supplier shall carry sufficient inventories to assure ex-stock supply of consumable spare parts or components for the Goods for a period of <i>[indicate here the time period specified. If not used indicate a time period of three times the warranty period]</i>.</p> <p>Spare parts or components shall be supplied as promptly as possible, but in any case, within <i>[insert appropriate time period]</i> months of placing the order.</p>

	<p><b>Packaging –</b></p> <p>The Supplier shall provide such packaging of the Goods as is required to prevent their damage or deterioration during transit to their final destination, as indicated in this Contract. The packaging shall be sufficient to withstand, without limitation, rough handling during transit and exposure to extreme temperatures, salt and precipitation during transit, and open storage. Packaging case size and weights shall take into consideration, where appropriate, the remoteness of the Goods’ final destination and the absence of heavy handling facilities at all points in transit.</p> <p>The packaging, marking, and documentation within and outside the packages shall comply strictly with such special requirements as shall be expressly provided for in the Contract, including additional requirements, if any, specified below, and in any subsequent instructions ordered by the Procuring Entity.</p> <p>The outer packaging must be clearly marked on at least four (4) sides as follows:</p> <p>Name of the Procuring Entity  Name of the Supplier  Contract Description  Final Destination  Gross weight  Any special lifting instructions  Any special handling instructions  Any relevant HAZCHEM classifications</p>
	<p>A packaging list identifying the contents and quantities of the package is to be placed on an accessible point of the outer packaging if practical. If not practical the packaging list is to be placed inside the outer packaging but outside the secondary packaging.</p> <p><b>Transportation –</b></p> <p>Where the Supplier is required under Contract to deliver the Goods CIF, CIP, or DDP, transport of the Goods to the port of destination or such other named place of destination in the Philippines, as shall be specified in this Contract, shall be arranged and paid for by the Supplier, and the cost thereof shall be included in the Contract Price.</p> <p>Where the Supplier is required under this Contract to transport the Goods to a specified place of destination within the Philippines, defined as the Project Site, transport to such place of destination in the Philippines, including insurance and storage, as shall be specified in this Contract, shall be arranged by the Supplier, and related costs shall be included in the contract price.</p>

	<p>Where the Supplier is required under Contract to deliver the Goods CIF, CIP or DDP, Goods are to be transported on carriers of Philippine registry. In the event that no carrier of Philippine registry is available, Goods may be shipped by a carrier which is not of Philippine registry provided that the Supplier obtains and presents to the Procuring Entity certification to this effect from the nearest Philippine consulate to the port of dispatch. In the event that carriers of Philippine registry are available but their schedule delays the Supplier in its performance of this Contract the period from when the Goods were first ready for shipment and the actual date of shipment the period of delay will be considered force majeure.</p> <p>The Procuring Entity accepts no liability for the damage of Goods during transit other than those prescribed by INCOTERMS for DDP deliveries. In the case of Goods supplied from within the Philippines or supplied by domestic Suppliers risk and title will not be deemed to have passed to the Procuring Entity until their receipt and final acceptance at the final destination.</p> <p><b>Intellectual Property Rights –</b></p> <p>The Supplier shall indemnify the Procuring Entity against all third-party claims of infringement of patent, trademark, or industrial design rights arising from use of the Goods or any part thereof.</p>
2.2	<p><i>[If partial payment is allowed, state]</i> “The terms of payment shall be as follows: _____.”</p>
4	<p>The inspections and tests that will be conducted are: bidders will be required to bring one sample of every bid item for compliance.</p>



## *Section VI. Schedule of Requirements*

The delivery schedule expressed as weeks/months stipulates hereafter a delivery date which is the date of delivery to the project site.

Item #	Description	Quantity	Unit	Unit Cost	Amount
1	Ball Valve (Stop Ball type 1" with lock wing Female Bronze)	50	pcs.		
2	Ball Valve (Stop Ball type 1/2" with lock wing Female Bronze)	1150	pcs.		
3	Brass Coupling 1"	250	pcs.		
4	GI Bushing Reducer 1" x 1/2"	10	pcs.		
5	GI Nipple 2" x 1"	410	pcs.		
6	GI Elbow 1/2"	1200	pcs.		
7	GI Elbow Reducer 3/4" X 1/2"	1660	pieces		
8	GI Nipple 1/2" x 2"	1610	pieces		
9	GI Nipple 1/2" x 8"	1400	pieces		
10	GI Nipple 1/2" x 12"	1500	pieces		
11	GI Nipple 1" x 6"	950	pieces		
12	GI Tee Reducer 1" X 1/2"	1300	pieces		
13	GI Elbow 1"	50	pieces		
14	GI Plug 1"	50	pieces		
15	DI Saddle Clamp 10" x 1"	5	pieces		
16	DI Saddle Clamp 8" x 1"	80	pieces		
17	DI Saddle Clamp 6" x 1"	70	pieces		
18	DI Saddle Clamp 4" x 1"	90	pieces		
19	DI Saddle Clamp 2" x 1"	10	pieces		
20	DI Sleeve Type Coupling (Long Body STC) 2"	25	pieces		
21	DI Sleeve Type Coupling (Long Body STC) 3"	10	pieces		
22	DI Sleeve Type Coupling (Long Body STC) 4"	20	pieces		

23	DI Sleeve Type Coupling (Long Body STC) 6"	10	pieces		
24	DI Sleeve Type Coupling (Long Body STC) 8"	30	pieces		
25	DI Sleeve Type Coupling (Long Body STC) 10"	6	pieces		
26	DI STC with Brass T. Ring 2"	5	pieces		
27	DI STC with Brass T. Ring 4"	5	pieces		
28	DI STC with Brass T. Ring 6"	10	pieces		
29	DI STC with Brass T. Ring 8"	5	pieces		
30	DI Tee 4 x 4 mech. w/ Metal Grip	5	pieces		
31	DI Elbow 4"x45° mech. w/ Metal Grip	10	pieces		
32	DI Elbow 4"x90° mech. w/ Metal Grip	1	pieces		
33	DI Elbow 4"x45° mech.	1	Pieces		
34	DI Elbow 4"x90° mech.	1	pieces		
35	DI Tee 6" x 6"	1	pieces		
36	DI Elbow 6" x 90° mech. w/ Metal Grip	1	pieces		
37	DI Elbow 6" x 90° mech.	1	pieces		
38	DI Elbow 6" x 45° mech.	1	pieces		
39	Thread Seal Tape	3,700	pieces		
40	Copper Wire	50	kg		
41	Lead Seal	50	kg		
42	DI Valve Box Cover	5	pieces		
43	Brass Check Valve 1/2"	850	pieces		
44	D.I St. Reducer 6 x 4	1	pieces		
45	D.I St. Reducer 4 x 2	1	pieces		
46	Wye-4" (C.I)	1	pieces		
			<b>TOTAL</b>		

## Section VII. Technical Specifications

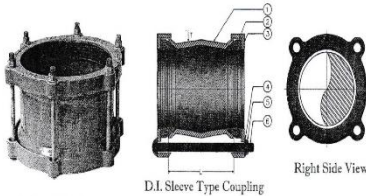
Item	Specification	Statement of Compliance																																								
	<p><b>GI Nipple</b> : Schedule 40-standard</p> <p><b>Thread Seal tape</b>: 1/2” x 0.1mm x 10m</p> <p><b>Sleeve Type Coupling</b>: ≥ 9” in length (made of D.I., color blue)</p> <div style="text-align: center;"> <p><b>D. I. Sleeve Type Coupling</b></p>  <p>D.I. Sleeve Type Coupling</p> <table border="1" style="display: inline-table; margin-right: 20px;"> <thead> <tr> <th>NOMINAL SIZE</th> <th>OUTSIDE PIPE PVC</th> </tr> </thead> <tbody> <tr><td>50</td><td>63</td></tr> <tr><td>75</td><td>90</td></tr> <tr><td>100</td><td>110</td></tr> <tr><td>150</td><td>160</td></tr> <tr><td>200</td><td>225</td></tr> <tr><td>250</td><td>280</td></tr> <tr><td>300</td><td>315</td></tr> </tbody> </table> <table style="display: inline-table;"> <tr> <td style="vertical-align: top;">PARTS:</td> <td style="vertical-align: top;">MATERIAL</td> </tr> <tr> <td>1. BODY</td> <td>DUCTILE IRON</td> </tr> <tr> <td>2. RUBBER SEAL</td> <td>RUBBER</td> </tr> <tr> <td>3. GLAND RING</td> <td>DUCTILE</td> </tr> <tr> <td>4. BOLTS</td> <td>STAINLESS STEEL</td> </tr> <tr> <td>5. NUTS</td> <td>STAINLESS STEEL</td> </tr> <tr> <td>6. WASHER</td> <td>STAINLESS STEEL</td> </tr> </table> </div> <p><b>Sleeve Type Coupling with Brass Tensile Ring</b></p> <table border="1" style="width: 100%; border-collapse: collapse;"> <tbody> <tr> <td style="width: 20%;">1. Body</td> <td>GGG50+FBE RAL5017</td> </tr> <tr> <td>2. Tensile Sealing Ring</td> <td>Brass+EPDM EN 681-1</td> </tr> <tr> <td>1. Bracket</td> <td>GGG50+FBE RAL5017</td> </tr> <tr> <td>2. Washer</td> <td>Carbon Steel Dacromet</td> </tr> <tr> <td>3. Nut</td> <td>Carbon Steel Dacromet</td> </tr> </tbody> </table>	NOMINAL SIZE	OUTSIDE PIPE PVC	50	63	75	90	100	110	150	160	200	225	250	280	300	315	PARTS:	MATERIAL	1. BODY	DUCTILE IRON	2. RUBBER SEAL	RUBBER	3. GLAND RING	DUCTILE	4. BOLTS	STAINLESS STEEL	5. NUTS	STAINLESS STEEL	6. WASHER	STAINLESS STEEL	1. Body	GGG50+FBE RAL5017	2. Tensile Sealing Ring	Brass+EPDM EN 681-1	1. Bracket	GGG50+FBE RAL5017	2. Washer	Carbon Steel Dacromet	3. Nut	Carbon Steel Dacromet	<p>Bidders must state here either “Comply” or “Not Comply” against each of the individual parameters of each Specification stating the corresponding performance parameter of the equipment offered. Statements of “Comply” or “Not Comply” must be supported by evidence in a Bidders Bid and cross-referenced to that evidence. Evidence shall be in the form of manufacturer’s un-amended sales literature, unconditional statements of specification and compliance issued by the manufacturer, samples, independent test data etc., as appropriate. A statement that is not supported by evidence or is subsequently found to be contradicted by the evidence presented will render the Bid under evaluation liable for rejection. A statement either in the Bidders statement of compliance or the supporting evidence that is found to be false either during Bid evaluation, post-qualification or the execution of the Contract may be regarded as fraudulent and render the Bidder or supplier liable for prosecution subject to the provisions of <b>ITB</b> Clause 3.1(a)(ii) and/or <b>GCC</b> Clause 2.1(a)(ii).</p>
NOMINAL SIZE	OUTSIDE PIPE PVC																																									
50	63																																									
75	90																																									
100	110																																									
150	160																																									
200	225																																									
250	280																																									
300	315																																									
PARTS:	MATERIAL																																									
1. BODY	DUCTILE IRON																																									
2. RUBBER SEAL	RUBBER																																									
3. GLAND RING	DUCTILE																																									
4. BOLTS	STAINLESS STEEL																																									
5. NUTS	STAINLESS STEEL																																									
6. WASHER	STAINLESS STEEL																																									
1. Body	GGG50+FBE RAL5017																																									
2. Tensile Sealing Ring	Brass+EPDM EN 681-1																																									
1. Bracket	GGG50+FBE RAL5017																																									
2. Washer	Carbon Steel Dacromet																																									
3. Nut	Carbon Steel Dacromet																																									

4. Square Neck Bolt	Carbon Steel Dacromet
5. Cap	Plastic

Size	OD	A	L	Blot Qty
PE50	55	140	90	2*M12
PE63	67	150	90	2*M12
PE75	80	150	90	2*M12
PE90	95	180	90	4*M12
PE110	115	200	90	4*M12
PE125	130	240	90	4*M12
PE160	165	270	90	4*M12
PE200	205	325	110	4*M12
PE225	230	325	110	4*M12
PE250	255	380	110	6*M12
PE280	285	380	110	6*M12
PE315	320	420	170	6*M12

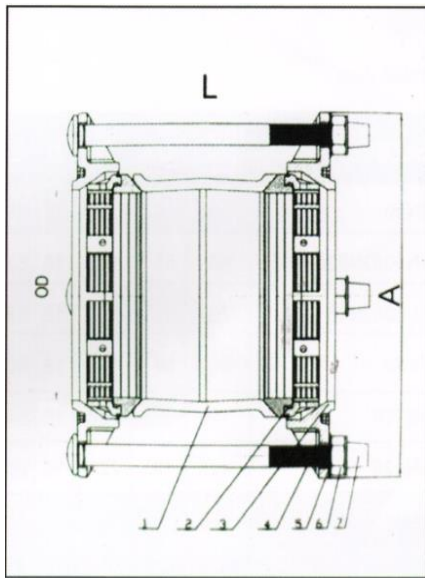

**D.I. Elbow Mechanical Type for uPVC/HDPE (comes with Tensile Restrained Metal Grip)**

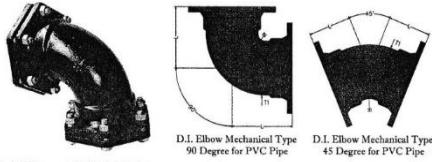

D. I. Elbow MJ/MJ 90 degree

NOMINAL SIZE	ID	T1
50	69	7
75	96	7
100	116	7.2
150	166	7.8
200	231	8.4
250	286	9
300	321	9.6

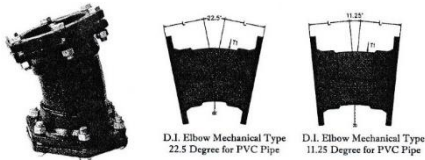

D. I. Elbow MJ/MJ 22.5 degree

NOMINAL SIZE	ID	T1
75	96	7
100	116	7.2
150	166	7.8
200	231	8.4
250	286	9
300	321	9.6

**D.I. End Cap Mechanical Type**

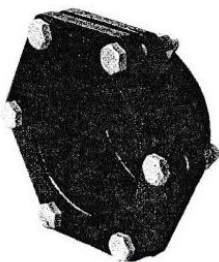

SIZE	OD OF PIPE PVC
50	63
75	90
100	110
150	160
200	225
250	280
300	315

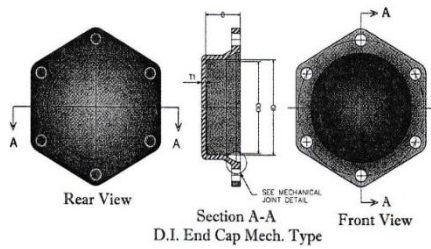

**Ductile Iron Saddle Clamp: Bolts is galvanized carriage bolt**

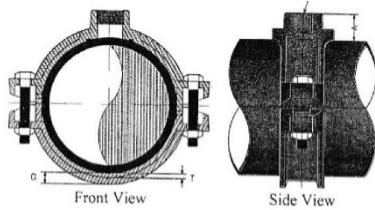
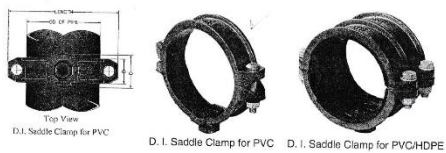

**NOTES:**

1. Material is ductile iron conforming to AST A-536.
2. Material of bolts and nuts is steel conforming to ASTM A-307 Grade B, and Galvanized as per ASTM A-153.
3. Materials of rubber ring gasket with narrow raised ridges is EPDM in compliance to ISO 4633 Class 70 and suitable for drinking water.
4. Coating is electrostatically applied epoxy powder.
5. Saddle shall not leak or break when tested under a pressure of 300 PSI.
6. This design is manufacturer's standard.

<u>NOMINAL PIPE SIZE</u>	<u>BOLT SIZE DIAMETER</u>	<u>OUTSIDE DIAMETER PVC PIPE</u>
50	12	63
75	12	90
100	12	110
150	12	160
200	16	225

**Ductile Iron Tee Mechanical: Bolts is galvanized carriage bolt**

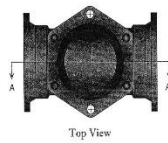
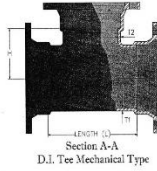
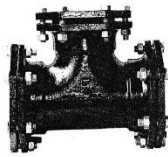

SIZE	
RUN	BRANCH
75	75
100	75
100	100
150	50
150	75
150	100
150	150
200	50
200	75
200	100
200	150
200	200
250	75
250	100
250	150
250	200
250	250
300	75
300	100
300	150
300	200
300	250
300	300

# ***Section VIII. Checklist of Technical and Financial Documents***

## **I. TECHNICAL COMPONENT ENVELOPE**

### ***Class “A” Documents***

#### **Legal Documents**

- (a) Valid PhilGEPS Registration Certificate (Platinum Membership) (all pages);  
**Or**
- (b) Registration certificate from Securities and Exchange Commission (SEC), Department of Trade and Industry (DTI) for sole proprietorship, or Cooperative Development Authority (CDA) for cooperatives or its equivalent document,  
**And**
- (c) Mayor’s or Business permit issued by the city or municipality where the principal place of business of the prospective bidder is located, or the equivalent document for Exclusive Economic Zones or Areas;  
**And**
- (d) Tax clearance per E.O. No. 398, s. 2005, as finally reviewed and approved by the Bureau of Internal Revenue (BIR).

#### **Technical Documents**

- (e) Statement of the prospective bidder of all its ongoing government and private contracts, including contracts awarded but not yet started, if any, whether similar or not similar in nature and complexity to the contract to be bid; **and**
- (f) Statement of the bidder’s Single Largest Completed Contract (SLCC) similar to the contract to be bid, except under conditions provided for in Sections 23.4.1.3 and 23.4.2.4 of the 2016 revised IRR of RA No. 9184, within the relevant period as provided in the Bidding Documents; **and**
- (g) Original copy of Bid Security. If in the form of a Surety Bond, submit also a certification issued by the Insurance Commission;  
**or**  
Original copy of Notarized Bid Securing Declaration; **and**
- (h) Conformity with the Technical Specifications, which may include production/delivery schedule, manpower requirements, and/or after-sales/parts, if applicable; **and**
- (i) Original duly signed Omnibus Sworn Statement (OSS);  
**and** if applicable, Original Notarized Secretary’s Certificate in case of a corporation, partnership, or cooperative; or Original Special Power of Attorney of all members of the joint venture giving full power and authority to its officer to sign the OSS and do acts to represent the Bidder.

#### **Financial Documents**



- (j) The Supplier's audited financial statements, showing, among others, the Supplier's total and current assets and liabilities, stamped "received" by the BIR or its duly accredited and authorized institutions, for the preceding calendar year which should not be earlier than two (2) years from the date of bid submission; **and**
- (k) The prospective bidder's computation of Net Financial Contracting Capacity (NFCC);  
**or**  
A committed Line of Credit from a Universal or Commercial Bank in lieu of its NFCC computation.

***Class "B" Documents***

- (l) If applicable, a duly signed joint venture agreement (JVA) in case the joint venture is already in existence;  
**or**  
duly notarized statements from all the potential joint venture partners stating that they will enter into and abide by the provisions of the JVA in the instance that the bid is successful.

**II. FINANCIAL COMPONENT ENVELOPE**

- (m) Original of duly signed and accomplished Financial Bid Form; **and**
- (n) Original of duly signed and accomplished Price Schedule(s).

*Other documentary requirements under RA No. 9184 (as applicable)*

- (o) *[For foreign bidders claiming by reason of their country's extension of reciprocal rights to Filipinos]* Certification from the relevant government office of their country stating that Filipinos are allowed to participate in government procurement activities for the same item or product.
- (p) Certification from the DTI if the Bidder claims preference as a Domestic Bidder or Domestic Entity.

